

IntelliStudio[®]

Automated
total body imaging
with integrated
body mapping



DermaGraphix[®]



Capture *both* Standard and
Cross-Polarized studio-quality
photos of the entire body in
under 2 minutes

IMAGING EXCELLENCE FROM
 **CANFIELD**



DermaGraphix body mapping solution



Fully automated capture of body map photos

DermaGraphix capture templates control camera settings and guide patient poses, while the motorized programmable lift ensures repeatable camera positions and lighting for consistent whole body photography with minimal staff training.

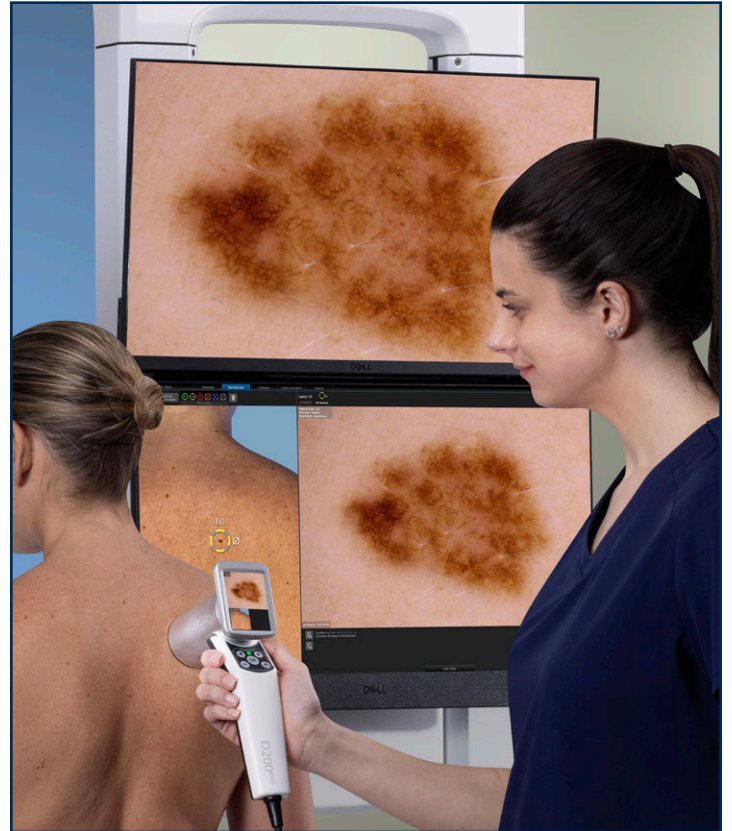

Capture dermoscopic images tagged to body map

All dermoscopic images associated with a lesion are linked to an automatically-generated unique number and tagged to the body map for efficient exams and accurate, workflow guided follow-ups.

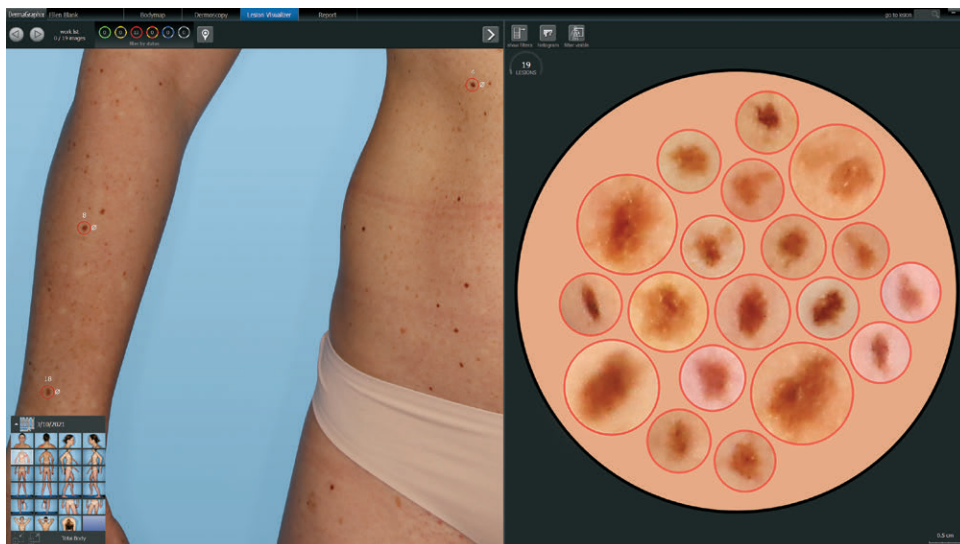

DermaGraphix can locate lesions on the overview image according to the clinician's own criteria (border, asymmetry, color). Spiral diagram mode can be used as a second look for the "ugly duckling", or by the medical staff to assist in selecting lesions for dermoscopy.

Improve efficiencies with

- EMR software via HL7 interfaces
- DICOM MWL and remote viewing
- Direct control of VivaScope® RCM

Simple but powerful review of both overview and dermoscopy images

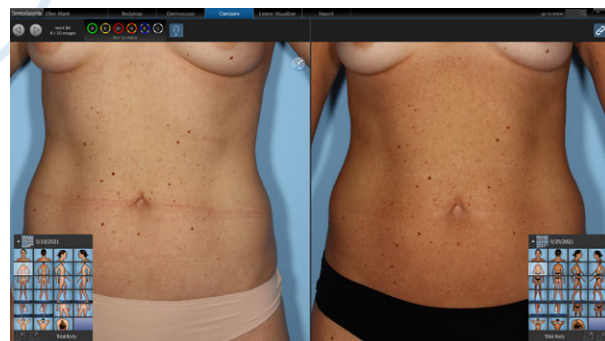

Canfield's Markerless Tracking automatically aligns skin surfaces from two body maps revealing new and changing lesions.

Easy surveillance of dermoscopic images
Full screen comparison between time points includes all image capture and lighting modalities.

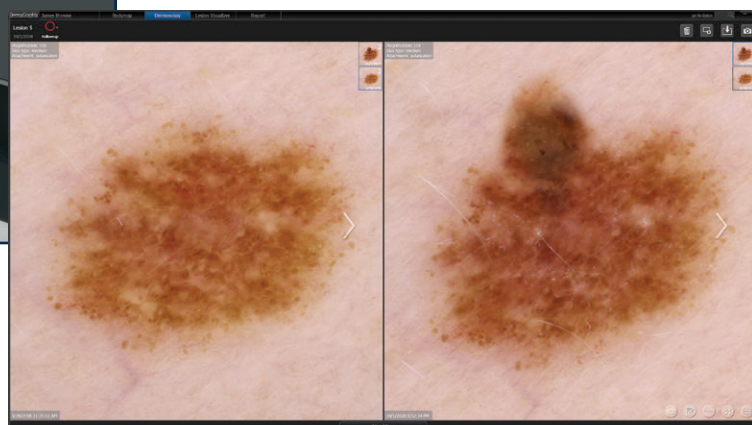

Faster reviews with better organized data

DermaGraphix Dashboard organizes dermoscopy images for optimal review and assessment, with **same lesion in a single column and same visit in a single row.**



ViewMyConsult[®] empowers patients to check for changes between office visits. In the privacy of their own home, your patient can access their overview and close-up images through a secure, HIPAA-compliant web portal with multi-factor authorization.

Also available as an exportable patient viewer for Windows[®] or macOS[®].

Printable lesion reports with 3-point, 7-point, and ABCD rule assessment results, clinical notes for billing, and patient referral fulfilment.



IntelliStudio®

Studio-quality LED lighting is calibrated and balanced for skin imaging.

45MP camera with full frame sensor allows for high magnification of the smallest skin features.



Non-polarized and cross-polarized lighting reveals skin features. Both lighting modes are captured sequentially in less than a second, enabling perfect registration.

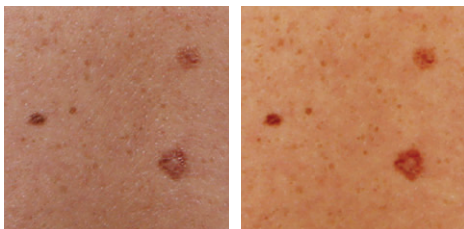

Standardized templates control camera settings and guide patient poses.

Motorized programmable lift ensures repeatable camera positions and lighting.

Automated sequencing guides the user through captures—no special photography skills needed.

MatchPose® overlay ensures registered before-and-after images.

Programmable zoom maximizes image resolution for face images and other smaller field captures.

Video with LED lighting and record, playback and zoom capabilities.

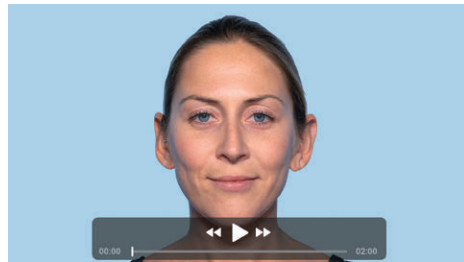

Auto facial recognition algorithms ensure that the patient's face is automatically recognized, setting the camera height for quick and repeatable patient positioning.

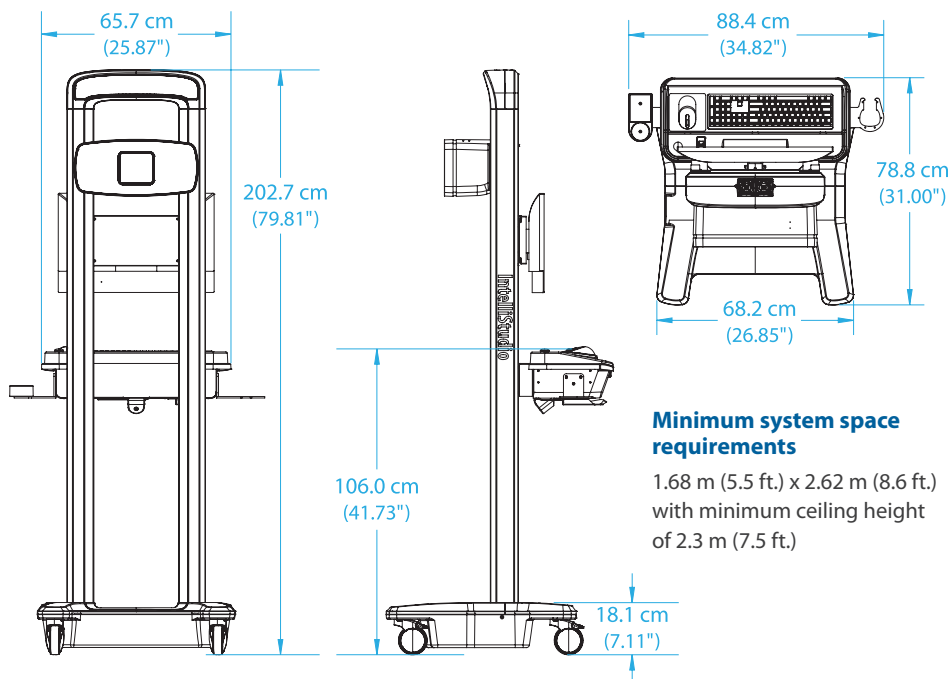

D200^{evo}

High-resolution digital dermatoscope— quality, flexibility and efficiency, all in a hand-held system

- 15–200x magnification
- Polarized and non-polarized lighting
- Tag and capture using the touch screen and keypad for computer-free dermatoscopy photos
- Capture both clinical and dermatoscopy photos



IMAGING EXCELLENCE FROM



www.canfieldsci.com / info@canfieldsci.com / phone +1.973.434.1201 / (USA) 800.815.4330

3D SOLUTIONS • FACIAL IMAGING & ANALYSIS • IMAGING SOFTWARE • PHOTOGRAPHY • RESEARCH SYSTEMS & SERVICES • TRAINING

IntelliStudio, DermaGraphix, and MatchPose are registered trademarks of Canfield Scientific, Inc.
VivaScope is a registered trademark of Caliber Imaging and Diagnostics.